

Vue intérieure

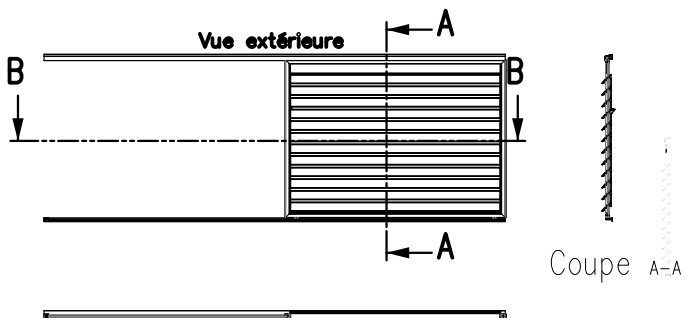

Vue extérieure

Coupe A-A

Coupe B-B

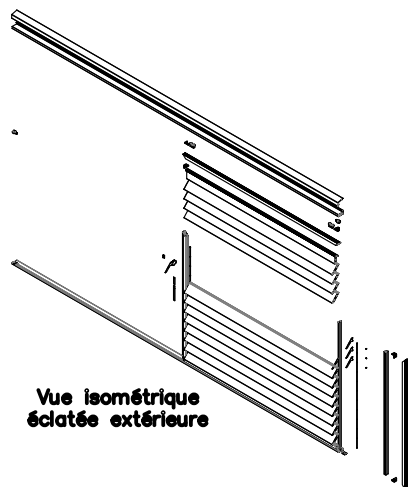

Vue isométrique éclatée extérieure

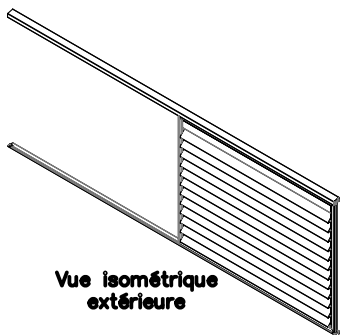

Vue isométrique extérieure

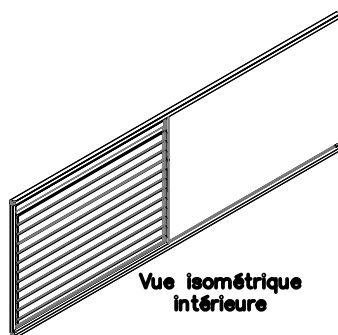

Vue isométrique intérieure

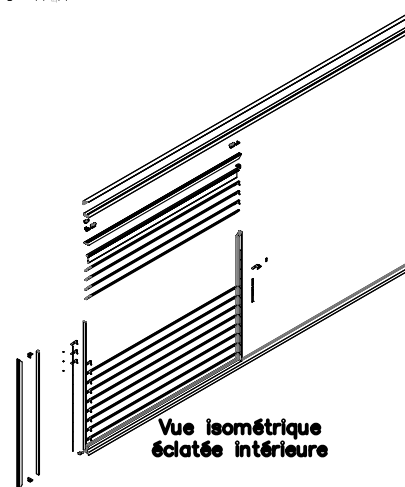

Vue isométrique éclatée intérieure



Bouchon n°10842



Vue isométrique

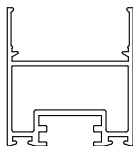

Profil de cadre n°12.216

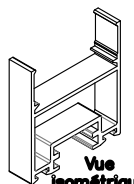

Vue isométrique



Tapée n°13043

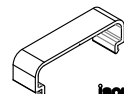

Vue isométrique

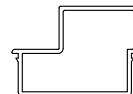

Bouchon de fixation des lames orientables

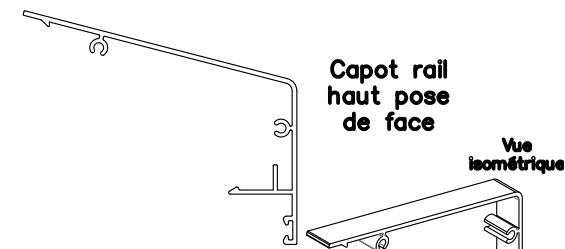
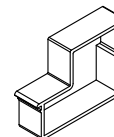

Capot rail haut pose de face

Vue isométrique

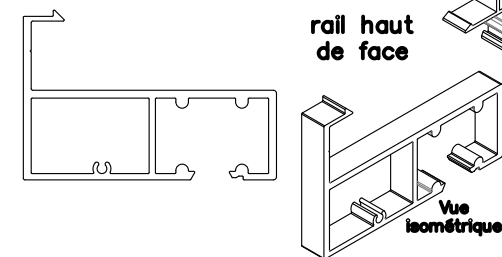

rail haut de face

Vue isométrique

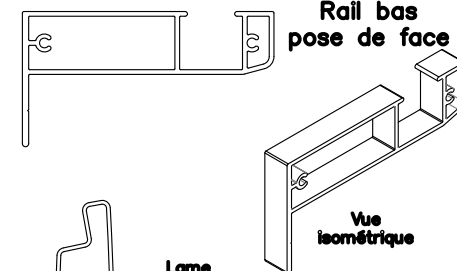

Rail bas pose de face

Vue isométrique

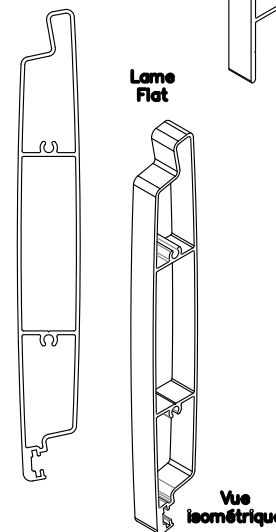

Lame Flat

Vue isométrique