

Lame Flat

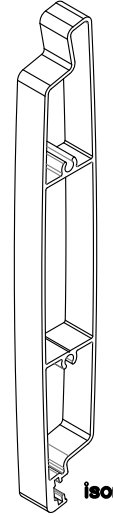

Vue isométrique

Coupe A-A



Coupe B-B

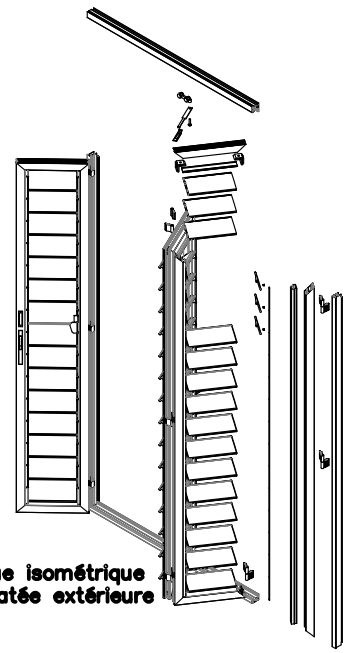

Vue isométrique éclatée extérieure

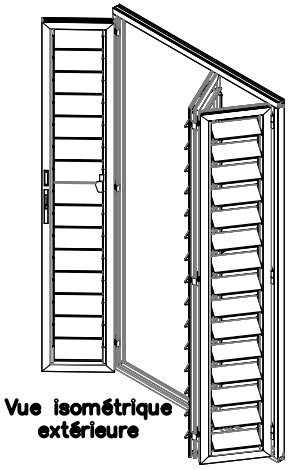

Vue isométrique extérieure

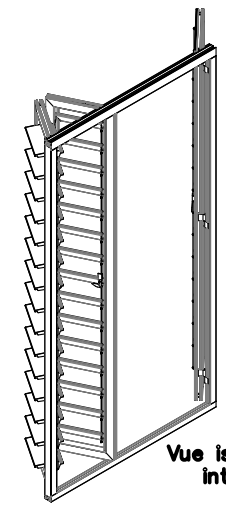

Vue isométrique intérieure

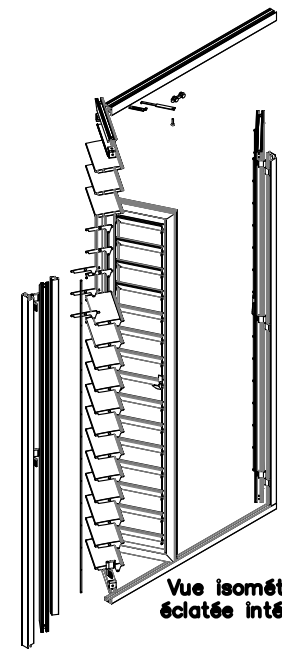

Vue isométrique éclatée intérieure

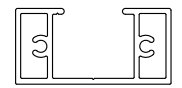

Rail bas pose plafond

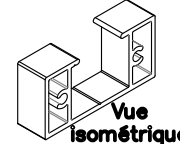

Vue isométrique



Bouchon n°10842



Vue isométrique

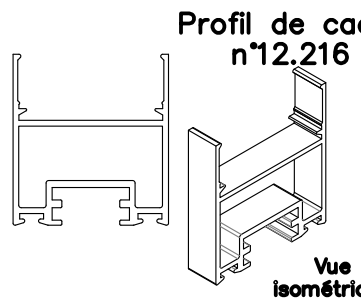

Profil de cadre n°12.216

Vue isométrique

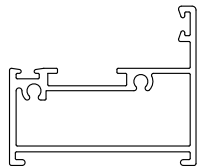

Précadre battant

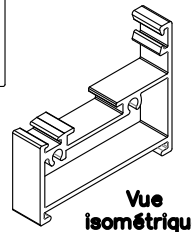

Vue isométrique

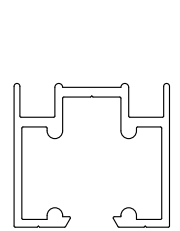

Rail haut pose plafond

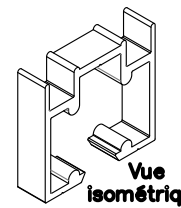

Vue isométrique

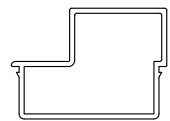

Bouchon de fixation des lames orientables

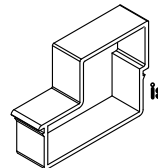

Vue isométrique