

Vue extérieure

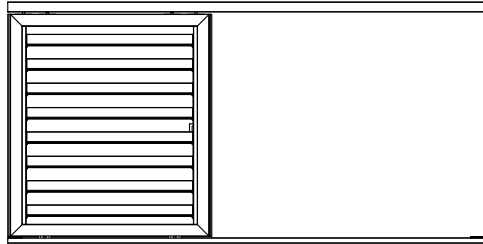

Vue intérieure

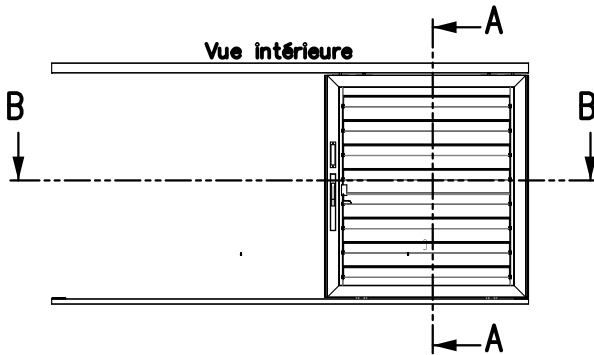

Coupe A-A



Bouchon de fixation des lames orientables

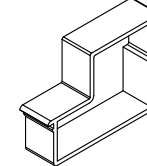
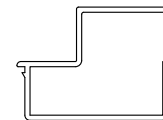

Lame Medina

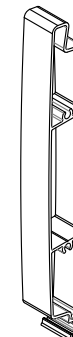

Vue isométrique

Coupe B-B



Vue isométrique éclatée intérieure

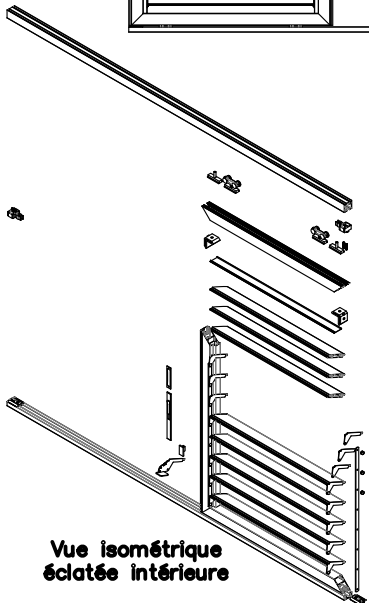

Vue isométrique intérieure

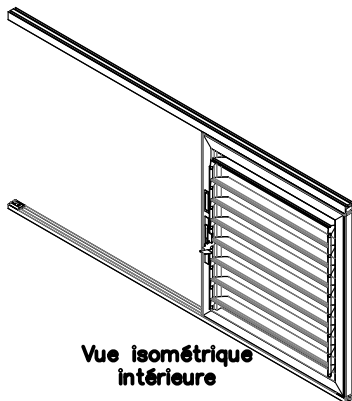

Vue isométrique extérieure

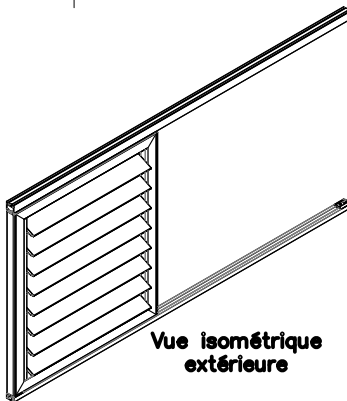

Vue isométrique éclatée extérieure

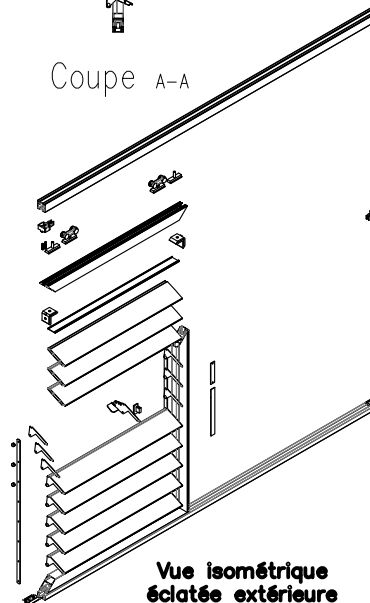

Tapée n°13043



Vue isométrique

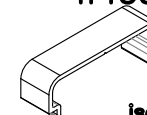

Bouchon n°10842



Vue isométrique

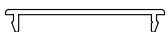

Profil de cadre n°12.216

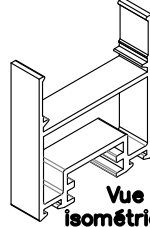
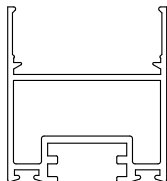

Vue isométrique

Rail haut pose plafond

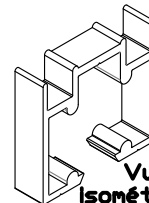
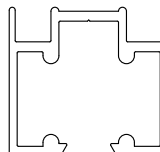

Vue isométrique

Rail bas pose plafond

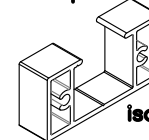
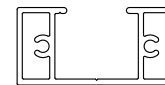

Vue isométrique