

Coupe B-B

Coupe A-A

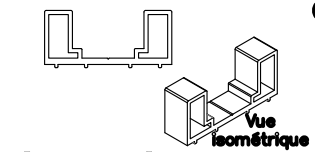

Guide pour projection

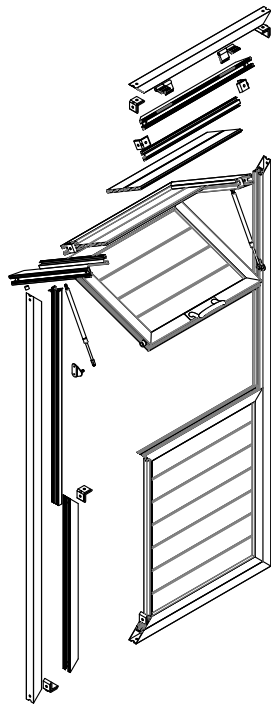
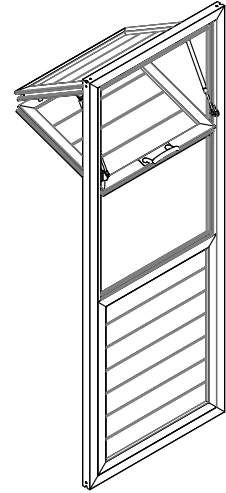
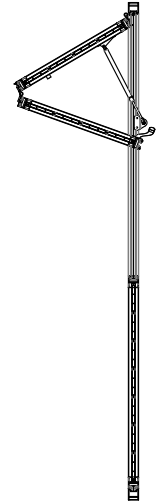
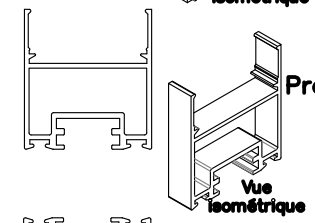

Profil de cadre n°12.216

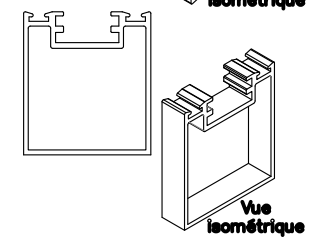

Précadre projection

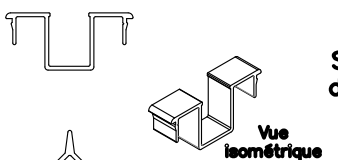

Support de lame

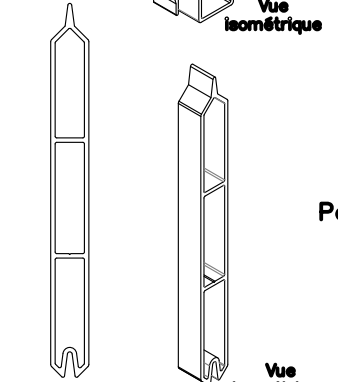

Panel 110

Vue isométrique