

Vue intérieure

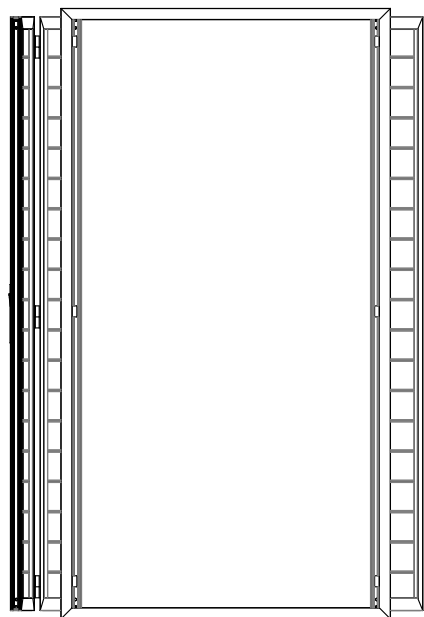

Vue extérieure

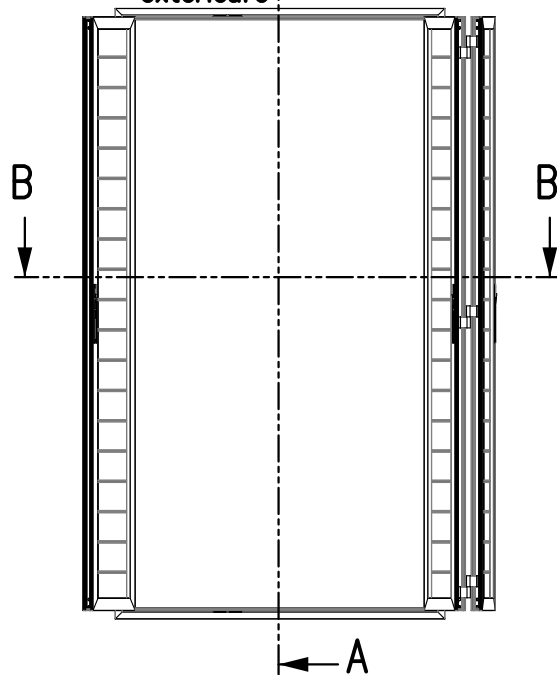

Coupe A-A

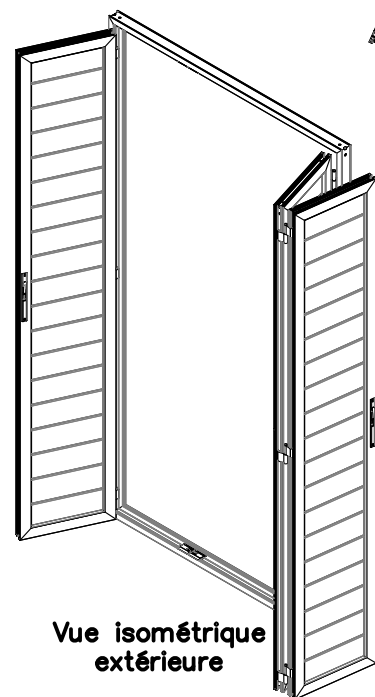
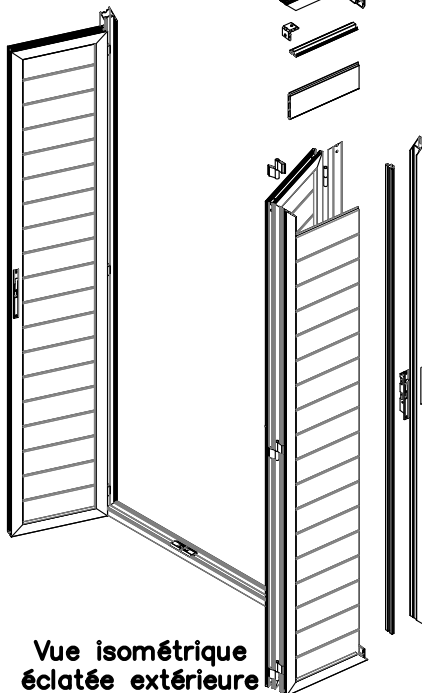
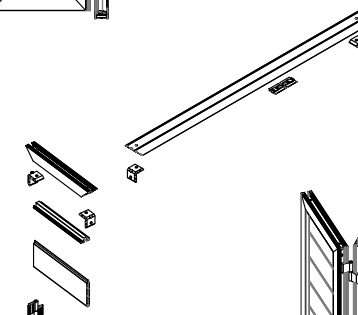
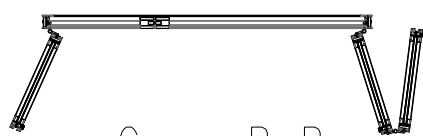
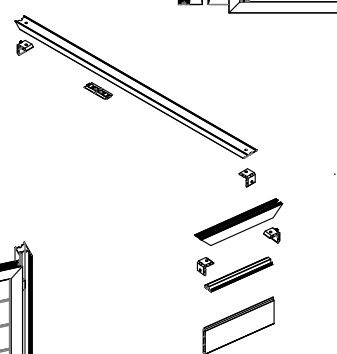
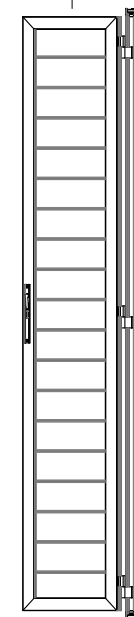

Coupe B-B

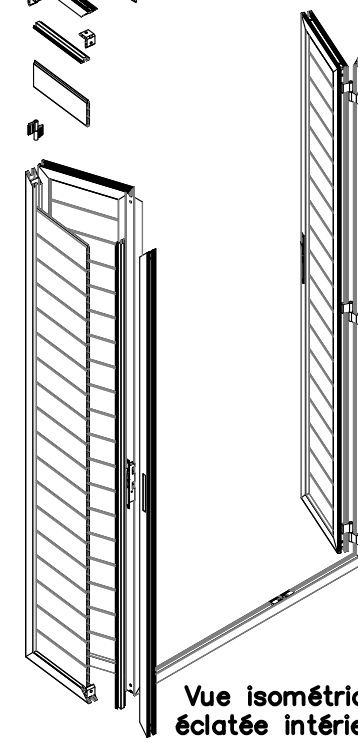
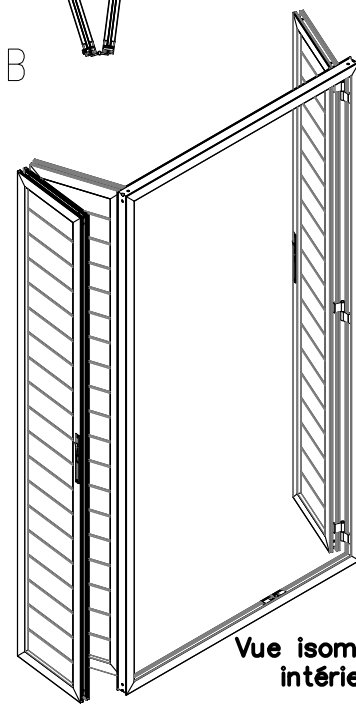

Vue isométrique éclatée extérieure

Vue isométrique extérieure

Vue isométrique intérieure

Vue isométrique éclatée intérieure

Précadre battant

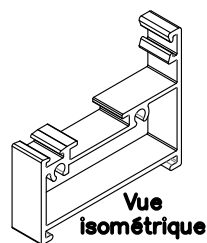
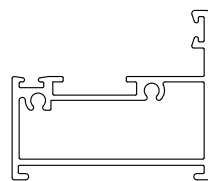

Profil de cadre n°12.216

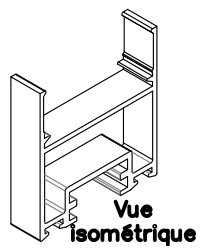
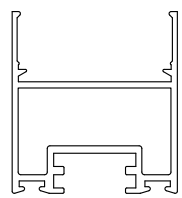

Bouchon n°10842

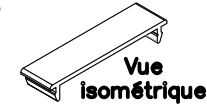

Panel 110

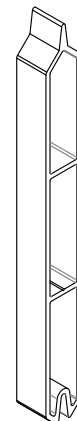

Vue isométrique